

Make sure that you have the latest version before using this document.

### 99"h and LESS SHELVING UNITS

- This bracing chart is the minimum requirement for single installation level of open shelving units. For installation with drawers, it is mandatory that each upright have braces.
- For closed shelving units, back and side panels must be bolted at every 24" center to center. No "X" back braces are required for closed unit.
- If you plan a two level installation (shelving over shelving or floor over shelving) or if additional capacities are required, please contact our customer service for bracing, floor anchoring and assembly instructions.
- For more information, please contact Rousseau's customer service.

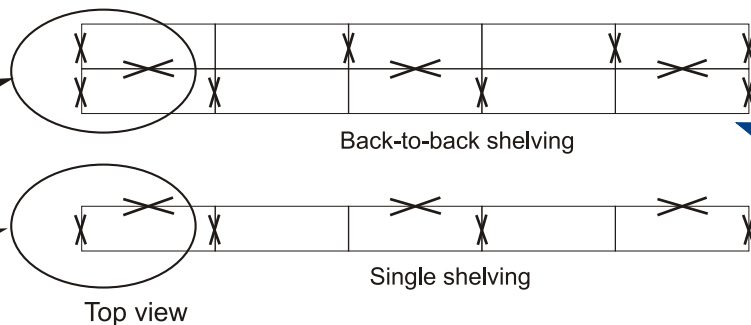
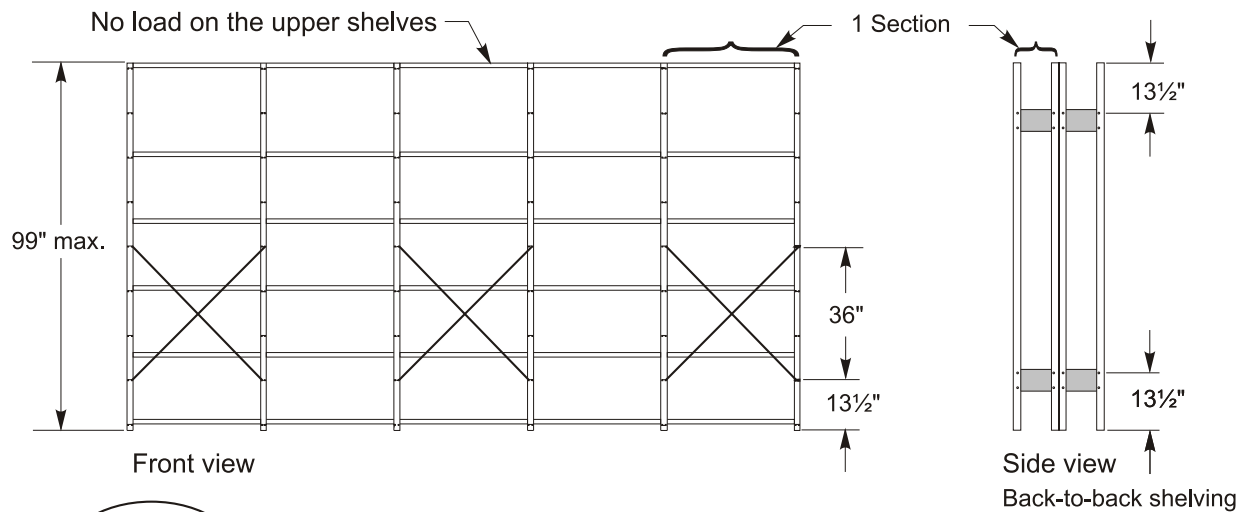

- At each end of a row, each upright assembly must include side braces.
- At each end of a row, each back-to-back or single unit must include "X" back braces.

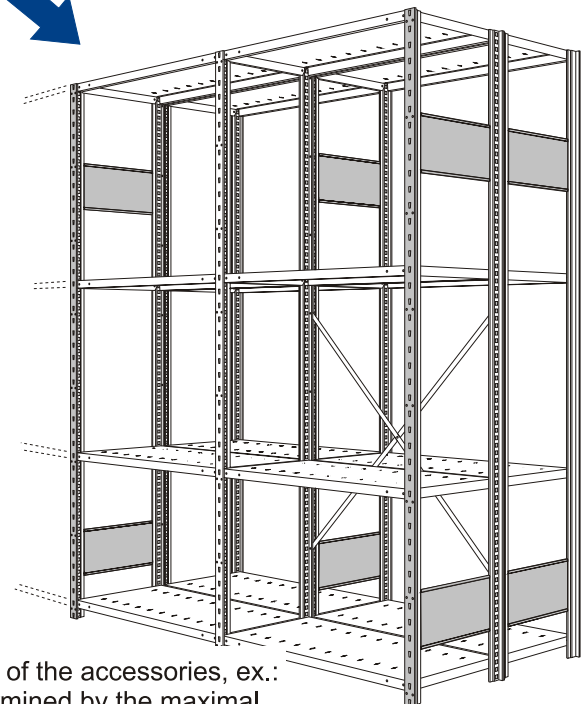
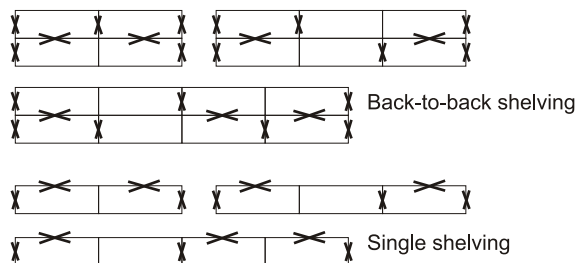

- 3500 lb max / section (weight evenly distributed, including the weight of the accessories, ex.: modular drawers). The weight to be considered on each shelf is determined by the maximal capacity of a section divided by the amount of shelves without exceeding shelf capacity.
- 36" max. C to C between two shelves

## SHELVING UNITS OVER 99"h to 123"h

- This bracing chart is the minimum requirement for single installation level of open shelving units. This chart does not include any provision for seismic considerations.
- For closing shelving, back panels can be combined with back braces to increase structural capacities. See capacities below. Side panels must be bolted at every 24" center to center. Back panels without back braces must be bolted at every 24" center to center.

- **Plumbness:**

The maximum vertical tolerance inclination must not exceed 1/2" inch in 10 feet in height.

Use floor plates and shims in order to level the shelving.

Floor plates must be anchored if more than one shim is used.

The total shims thickness must not exceed 7/8".

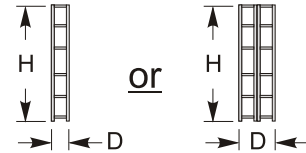
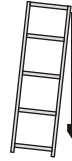

- **Anchoring of shelving:**

Shelving units must be anchored to the floor when height/depth ratio exceeds 4.

Ex.: 123" h / 24" d = 5.125 > 4

- If you plan a two level installation (shelving over shelving or floor over shelving), please contact our customer service for bracing, floor anchoring and assembly instructions.

- Concerning shelf capacities, more than 123"H shelving or on seismic zones, contact our customer service.

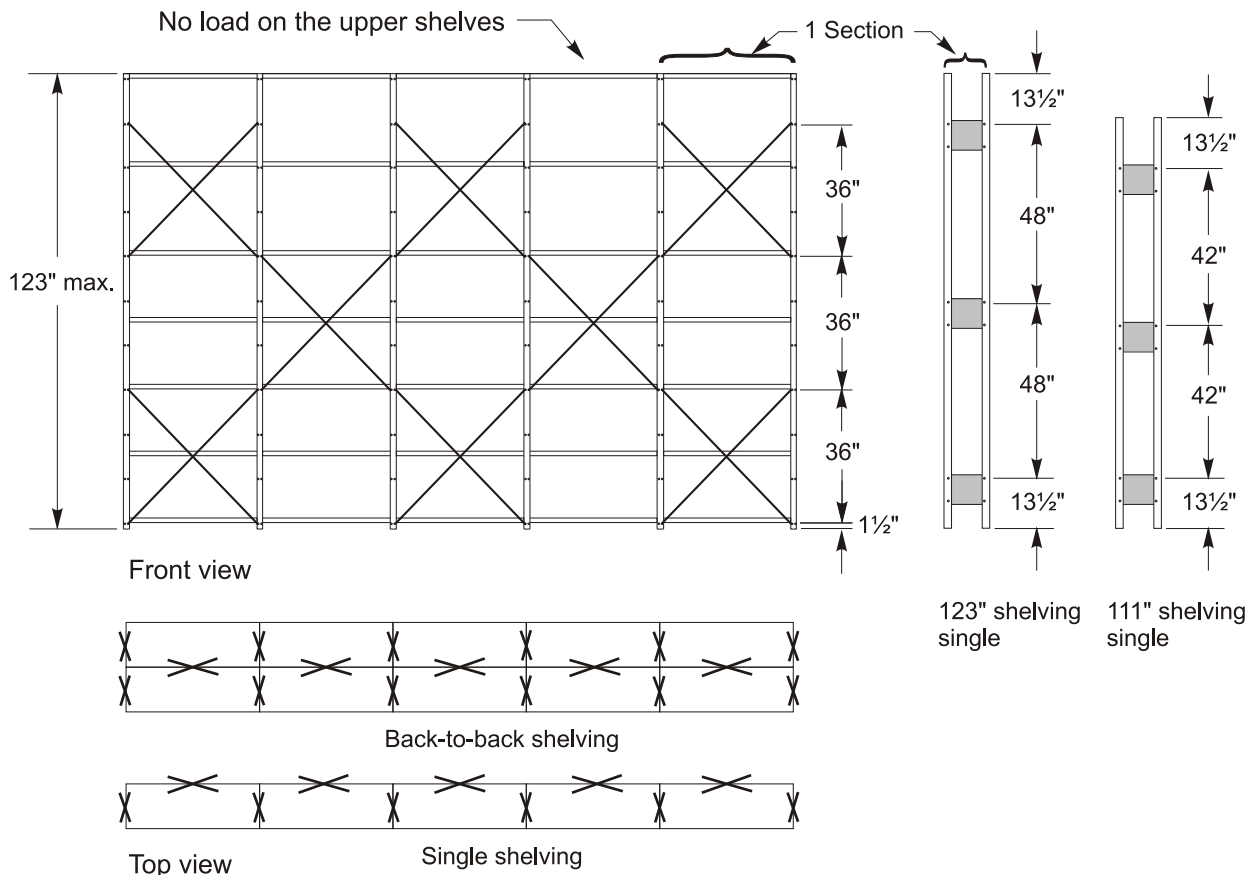

- **Closed shelving:**

3400 lb max. / section (weight evenly distributed, including the weight of the accessories, ex.: modular drawers).

- **Open shelving or closed shelving with back braces:**

5400 lb max. / section (weight evenly distributed, including the weight of the accessories, ex.: modular drawers).

- The weight to be considered on each shelf is determined by the maximal capacity of a section divided by the amount of shelves without exceeding shelf capacity.

- 36" max. c/c between two shelves.